

Technical specification

Mounting torque: max. 25 Nm
 Operating temperature: -40°C ... +125°C
 Media temperature: -50°C ... +135°C

Type label description

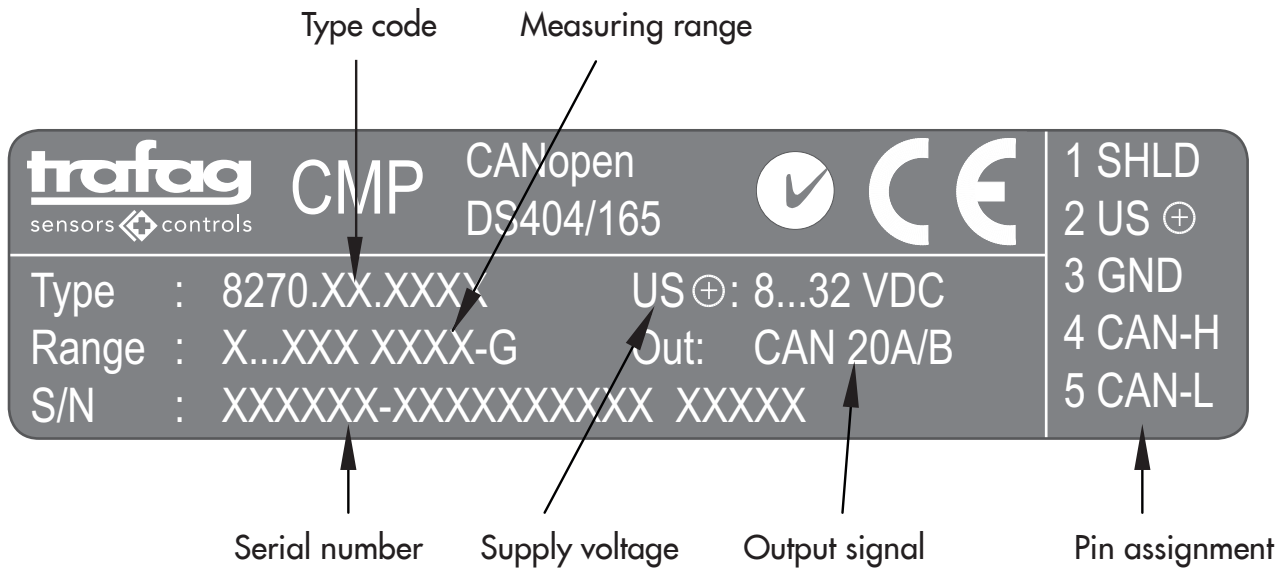

Electrical connections

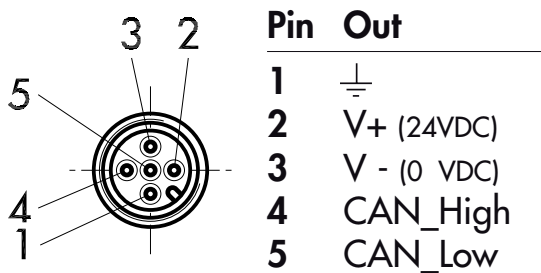

CANopen-protocol

Output signal:	CAN BUS (ISO 118982)
CANopen:	DS-301 V4.0
Device profile:	DS-404 V1.2
Baudrate:	10kbit/s...1Mbit/s, Auto
Error control:	Nodeguarding, Heartbeat
Node ID:	LSS (DSP 305 V2.0) full implemented, proprietary
No. of PDO's:	4 Tx
PDO modes:	event-/time-triggered remotely requested sync (cyclic), sync (acyclic)
PDO linking:	yes
PDO mapping:	yes
No. of SDO's:	1 server
Emergency message:	yes
CiA certified:	yes

DIMENSIONS

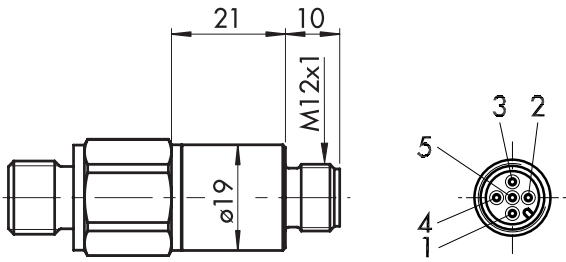

8270.XX.XXXX.35.XX.XX.XX

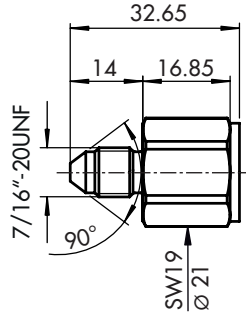

8270.XX.XX18.XX.XX

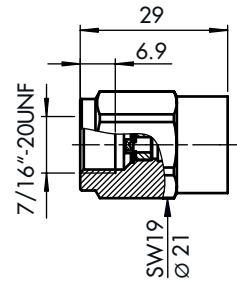

8270.XX.XX24.XX.XX

≤ 0 ...2.5 bar

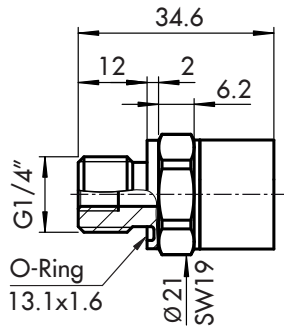

8270.XX.XX17.XX.XX...

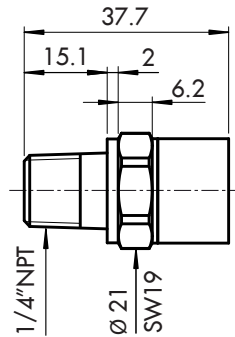

8270.XX.XX30.XX.XX...

> 0 ...2.5 bar

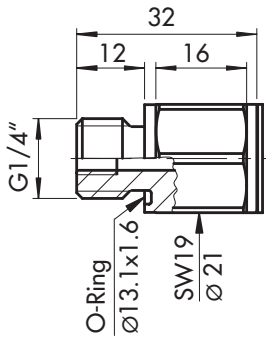

8270.XX.XX17.XX.XX...

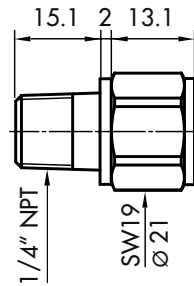

8270.XX.XX30.XX.XX...

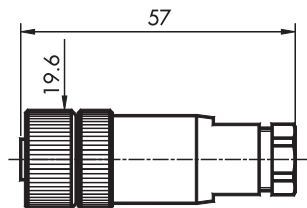

8270.XX.XXXX.XX.XX.33